

# Manual Gabion Fence with profile.

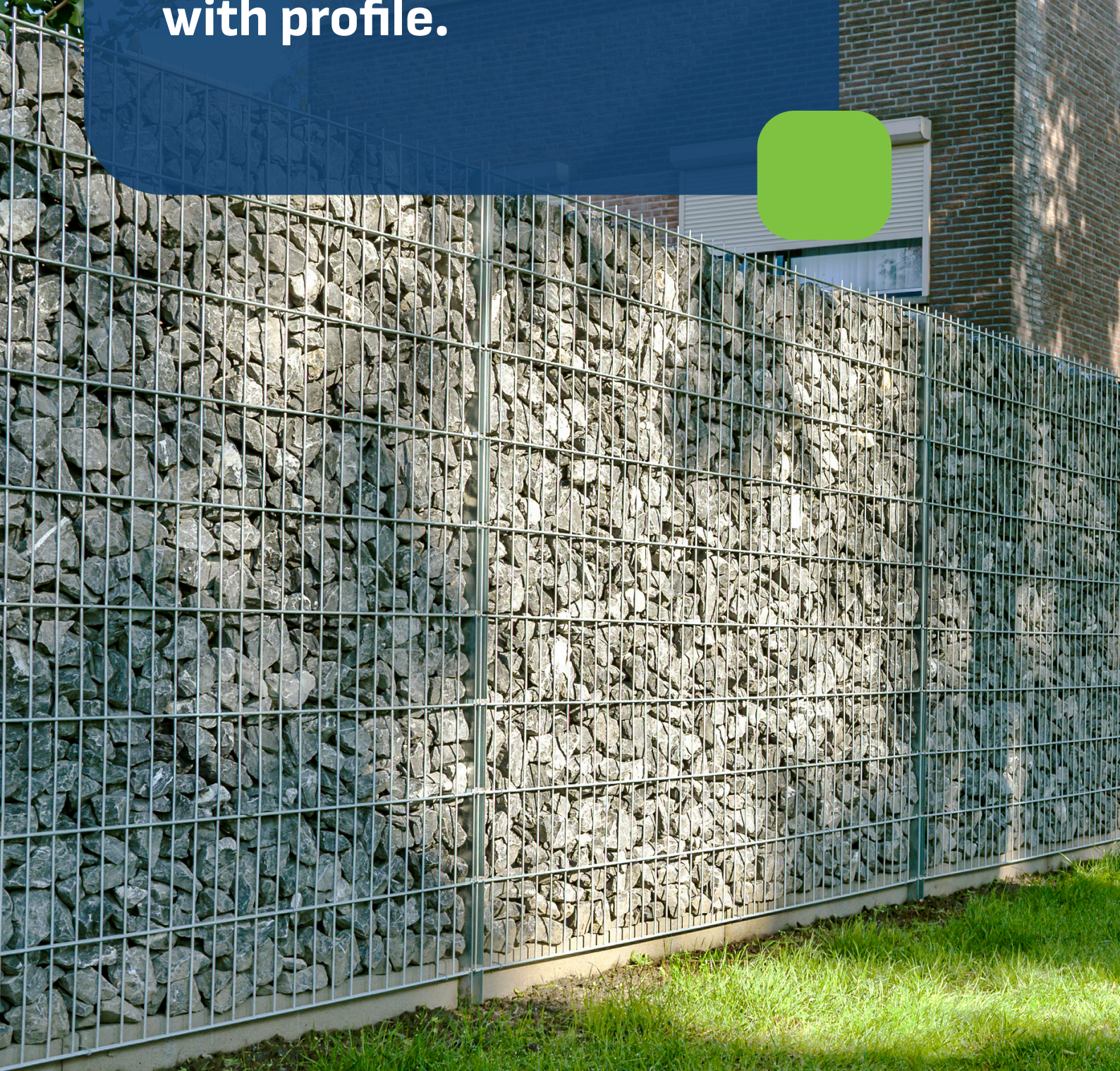



# Personal protective equipment.

Gabion Fence with profile.



# What is needed to install the gabion fence?

Gabion Fence with profile.

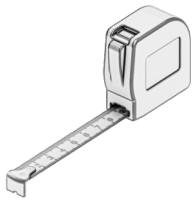

Tape measure



Shovel /  
auger

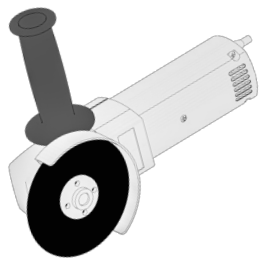

Angle grinder with diamond blade

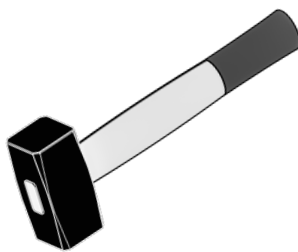

(Rubber) Hammer

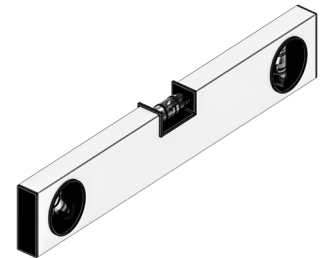

Level



Rope / wire



Pipe wrench

**Make it even easier for yourself.  
The following could also  
come in handy!**

- Postdriver
- Blanket voor een zachte ondergrond.
- Boxcutter
- A piece of wood in the same size as a fencepanel.

# Check your order.

## Gabion Fence with profile.

The fencing, the posts, the gate and concrete are delivered on a pallet, possibly on several for large orders. Small orders are placed upright and tied to a wooden trestle and finally sealed. Large orders transported on big pallets are usually not sealed in foil.



Check the goods upon delivery and note any damage on the consignment note before signing. **(after signing the right of complaint expires).**



Keep the order in a safe and covered place until assembly to keep it in good condition.



# Carefully remove the products from the pallet.

Gabion Fence with profile.

Carefully cut open the foil with a boxcutter without damaging the products (Best on the short side of the pallet).

Then cut the green straps and pull them off the pallet. Carefully remove the products from the pallet.



Do you have posts or cover strips with your order? Make sure to lift them up properly when you remove them from the pallet, this way you prevent scratches.



# Overview: Gabion Fence with profile.

Gabion Fence with profile.

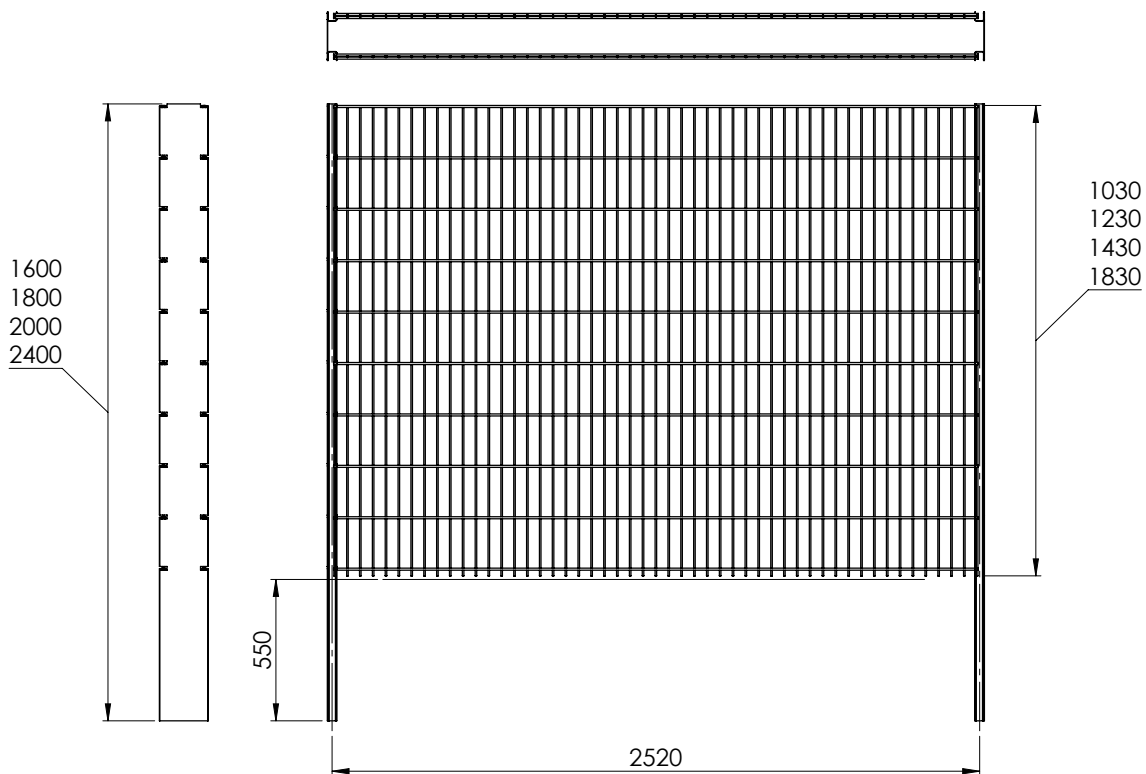

Distance from center to center

\*Center to center is the distance between the center of one object and the center of the other object.  
So from the center (middle) of the first post to the other center (middle) of the second post.

First read the manual carefully and make a plan of action before you start assembling. Only then start with the assembly.



# Preparation: Measuring is knowing.

Gabion Fence with profile.

- 1 Level the ground at the location where the fencing will be placed. Free up enough space to work properly.
- 2 Determine the starting point of your fence. This starting point must not be able to change in dimensions later.
- 3 Measure where the posts should be positioned approximately. For correct positioning of the posts, measure from the centre of the profiles.  
(The centre-to-centre measurement\*)
- 4 Stretch a wire along which your fence must be placed. Use picket posts here if necessary.
- 5 When you have corners, decide how to create the corners. See images:

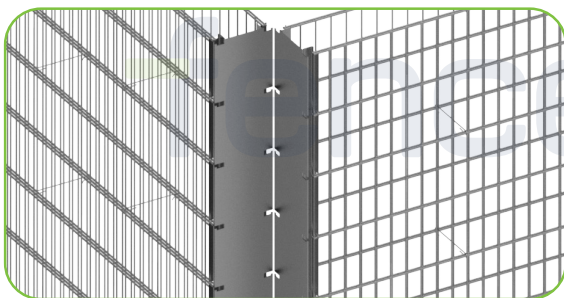

The fence panels end at the profiles.

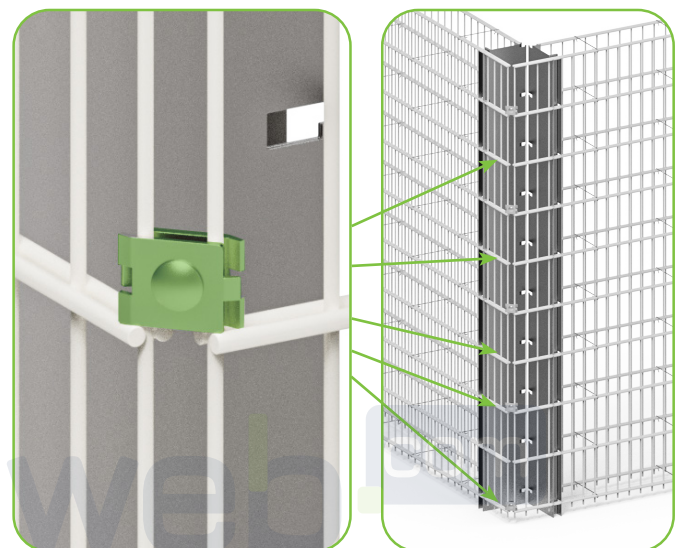

The fence panels go beyond the posts and touch each other. Tip: For a good finish, you can choose to finish the corner with corner clamps. This way, this corner can also be filled with stones or other materials.



# Installation: The first post.

## Gabion Fence with profile.

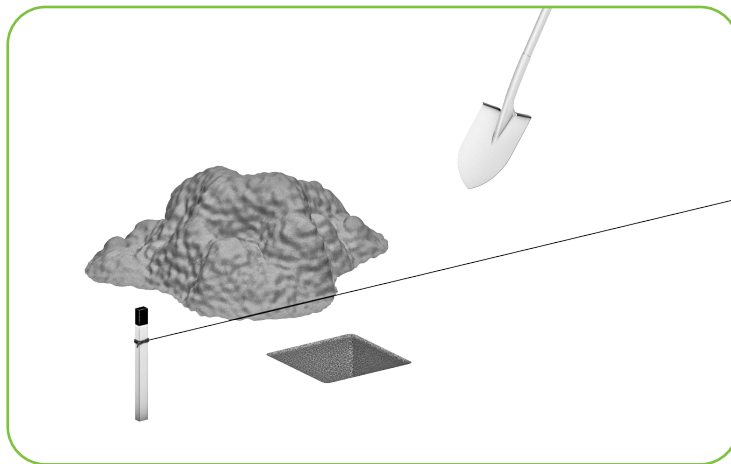

**6** Drill or dig a hole of about 30 x 30 cm where the first post is to be placed. Remove any stones, roots or other material from the ground where the posts will be placed.



**7** Place the post in the hole. The part without slots goes into the ground. Check that it is level and against the taut wire, but make sure that the pole just does not touch the wire. Then bring it into the ground to the correct height. Use a rubber hammer for this if necessary, or add some sand again. The i-profile generally goes 55 cm into the ground. We recommend placing the fence at least 5 cm above ground level.

**8** Secure the post with (quick) concrete. Follow the instructions on the packaging. We can not guarantee the safety and strength of the gabion fence.

Let the concrete harden before loading the post.

# Installation: The first post.

Gabion Fence with profile.

When assembling a fence for the first time, we recommend starting the assembly with one fence. From there, you can measure how far apart the posts should be and apply any corrections. **Posts once set in concrete are not easy to move.**



It is wise to install the fences with two or more people.

- 9 Measure where the second hole should be and dig or drill it out.

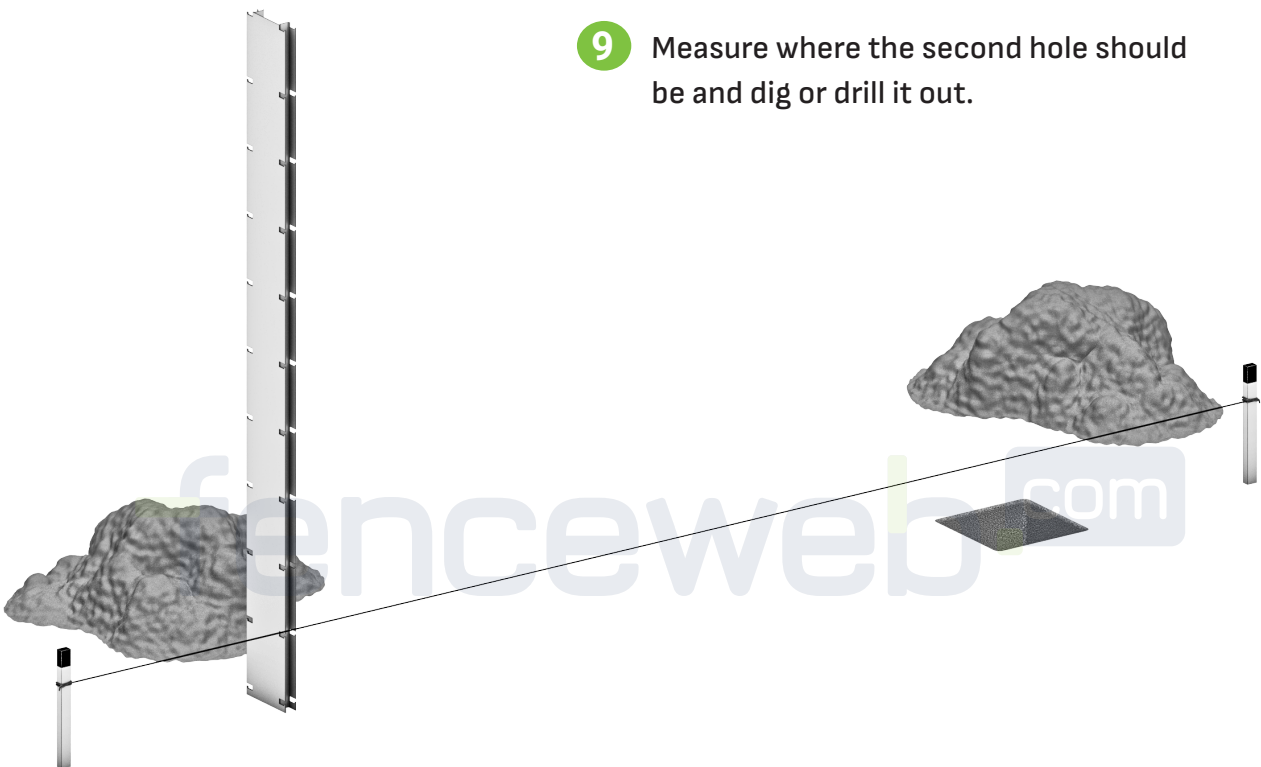



# Installation: the second post.

Gabion Fence with profile.

**10** Place the second profile in this hole, (almost) against the tensioned wire. While holding the profile in place, hold the fence next to the profiles and check that the fence falls into the slots. Correct the position of the profile if necessary.

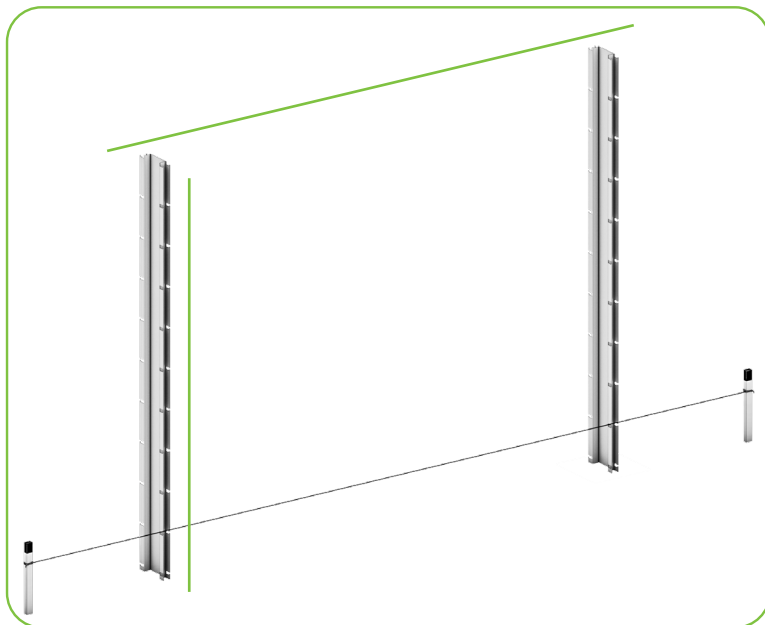
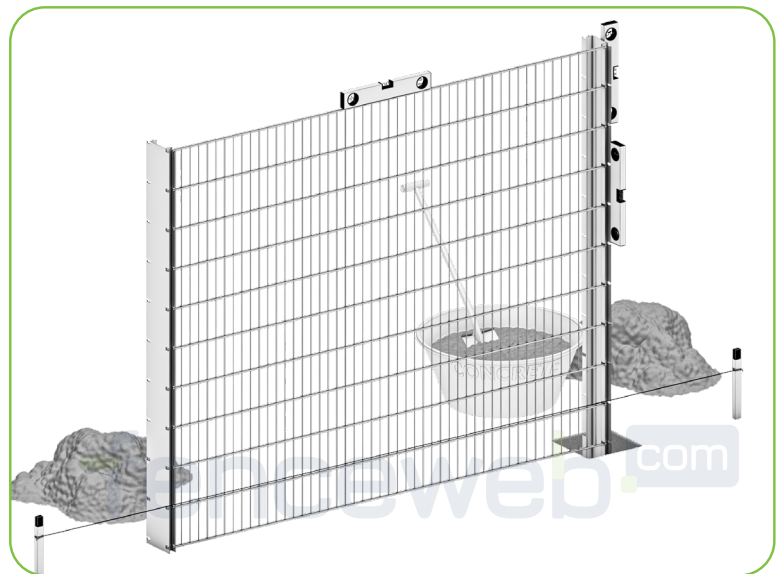

**11** When the post is in the correct position, put the fence away again and secure the post with concrete. Make sure the post is perpendicular and level with the other post during curing.

# Installation: The first fencepanels.

Gabion Fence with profile.

- 12** When both posts are firmly set in concrete, hang the fence from the posts. Check that it hangs level. If it does not hang level, correct one or both posts.

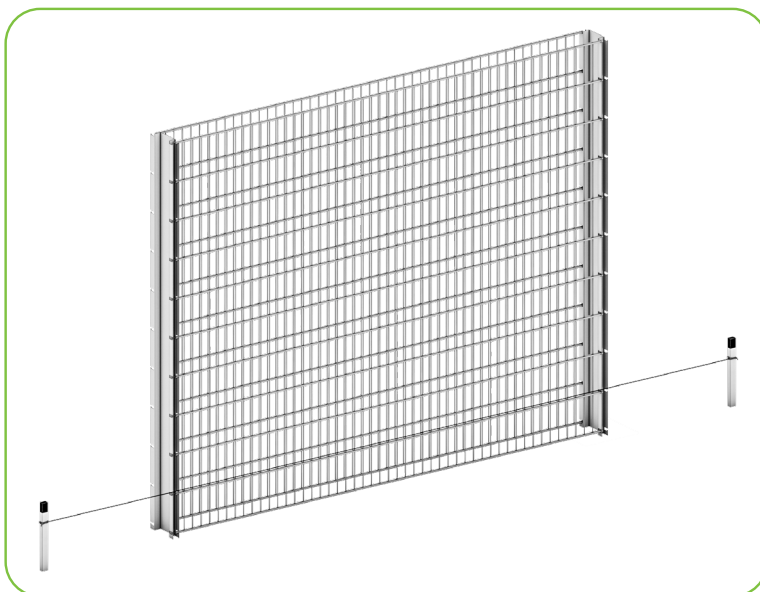
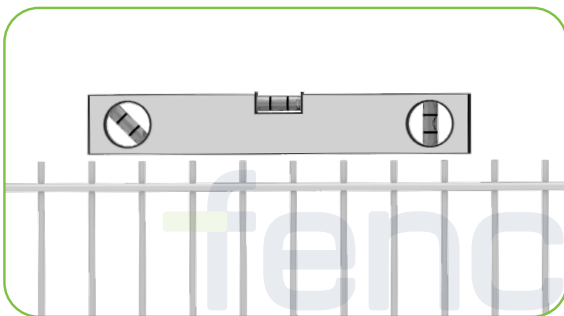

You can choose whether to mount the fences with the points up or down. Often the fences at the gabion are mounted with the points down.

- 13** Then, for the strength of the gabion, hang the second fence panel on the other side of the profile.

After this you can then start digging the hole for the next profile.



# Installation: Grind the last fencepanels and spray the ends with paint.

Gabion Fence with profile.

- 14** Repeat the steps until you reach the end of your gabion fence.

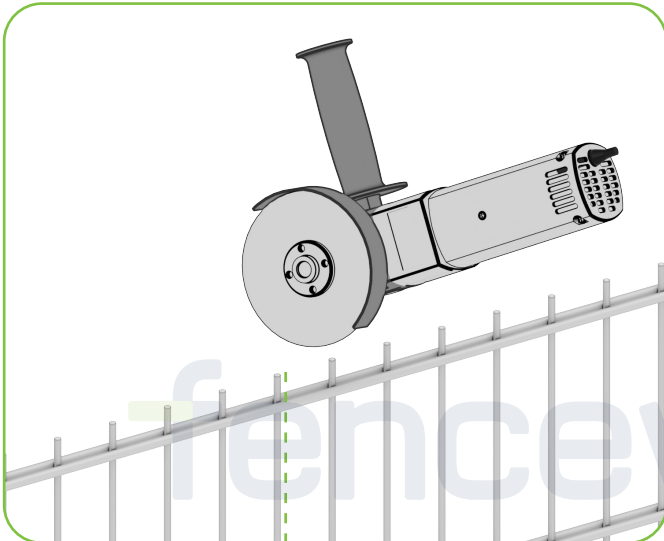

- 15** Do you have a part left up to the last post where a whole panel won't fit in between? Then you will have to shorten a fence panel. Do this with a grinder. Use the spray can to paint the grinded ends. This will prevent the fence from rusting.



# Installation: Afstandhouders bevestigen aan de onderkant van het hekwerk.

Gabion Fence with profile.

- 16** Then distribute all spacers per fence panel. The two fence panels are connected by spacers. Every row of 20 cm high meshes is one layer. The bottom of each layer gets 6 spacers, then finally at the very end on top, there are also 6 spacers. Spacers prevent the fence panels from bending outwards when the gabion is filled with stones.

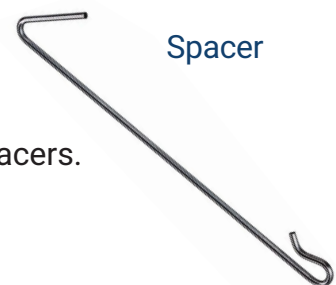

Do not first place all the spacers at once, but place them layer by layer. Start with the lowest layer, fill it with stones and fix the next 6 spacers on top. Continue in this way, layer by layer.  
Caution! When the stones fall on top of the spacers, they become warped and will cause the fence panels to bend inwards.



- 17** Start at the bottom double wires. Place a spacer approximately every 35 cm (7 meshes). When the 6 hooks on a layer are in the right place, you can squeeze the open side closed with a pipe wrench. (See image on next page)

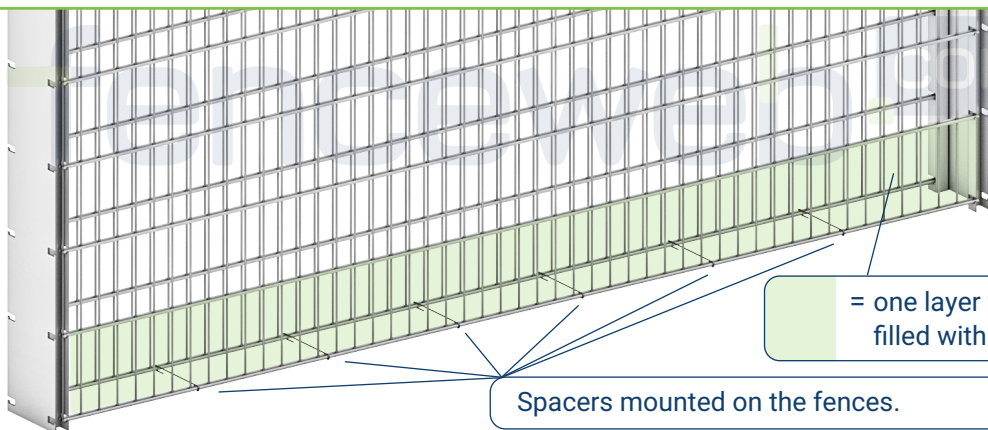



# Installation: Fill the gabion with stones layer by layer.

Gabion Fence with profile.



- 18** Only when the spacers are in place and secure can you fill the next layer with stones. Repeat this step until the gabion is filled to the top and there are 6 spacers between each layer.



# Installation: Fill the gabion with stones layer by layer.

Gabion Fence with profile.

- 19 Finally, place 6 spacers on the top double wires as well and close them with the pipe wrench.

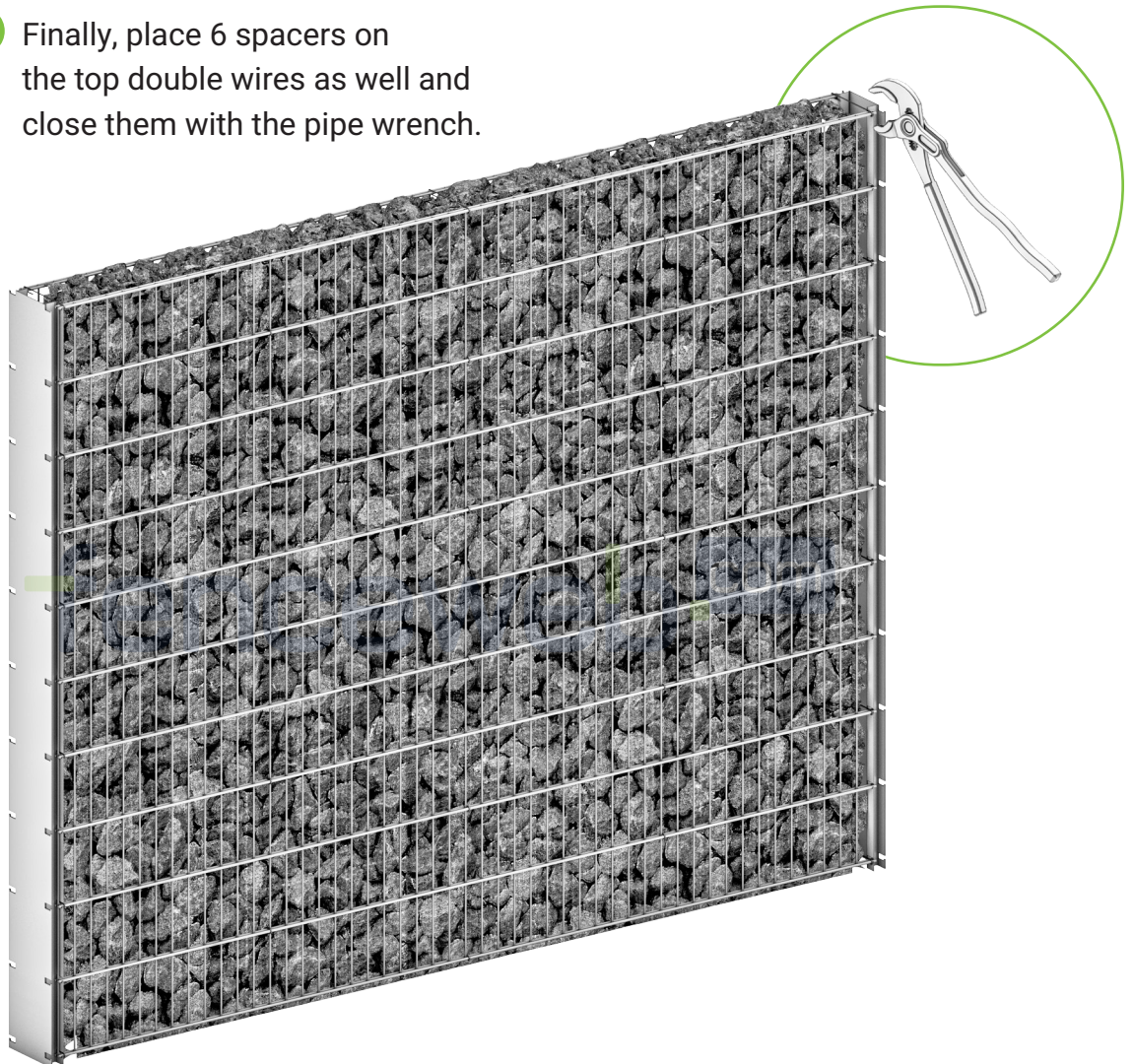



# Congratulations, your gabion fence is installed!

Gabion Fence with profile.

Do not forget to take pictures of your brand new gabion fence and send them to: [business@fenceweb.com](mailto:business@fenceweb.com) or to post it with #hekwerkonline!

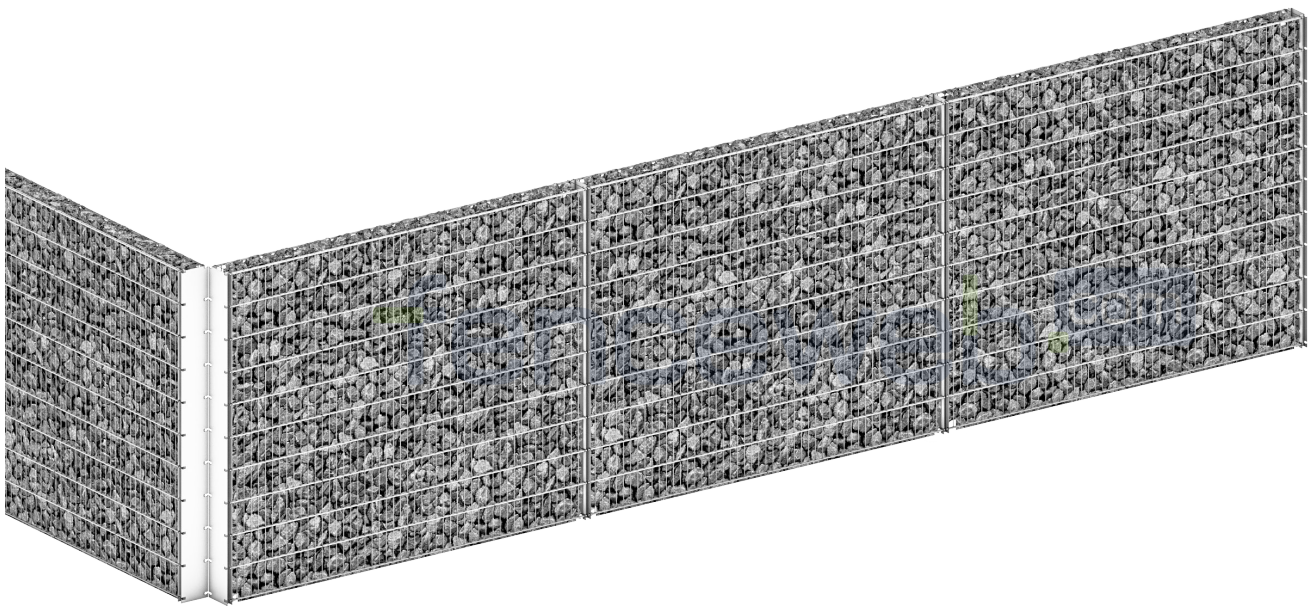

We would love to hear your feedback on this manual to improve our service.



Send your comments to: [business@fenceweb.com](mailto:business@fenceweb.com)



# These people also installed a gabion fence!

Gabion Fence with profile.

