

TUINDECO

LEADING IN GARDEN PRODUCTS

40.0890

Annette



233

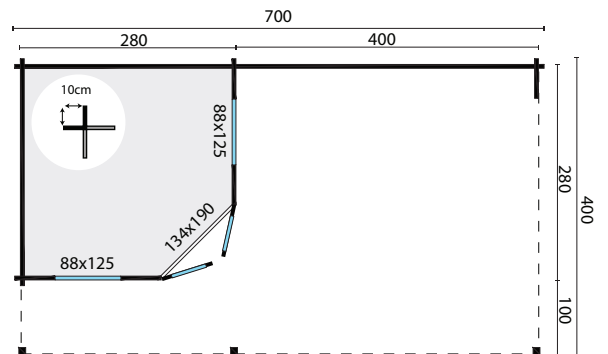

All sizes are approximate and in cm



6,9+17,1m²



-



17,2m³



40mm



28,0m²



3-6-3mm



1350kg



600x114x65cm

cabin:
Annette

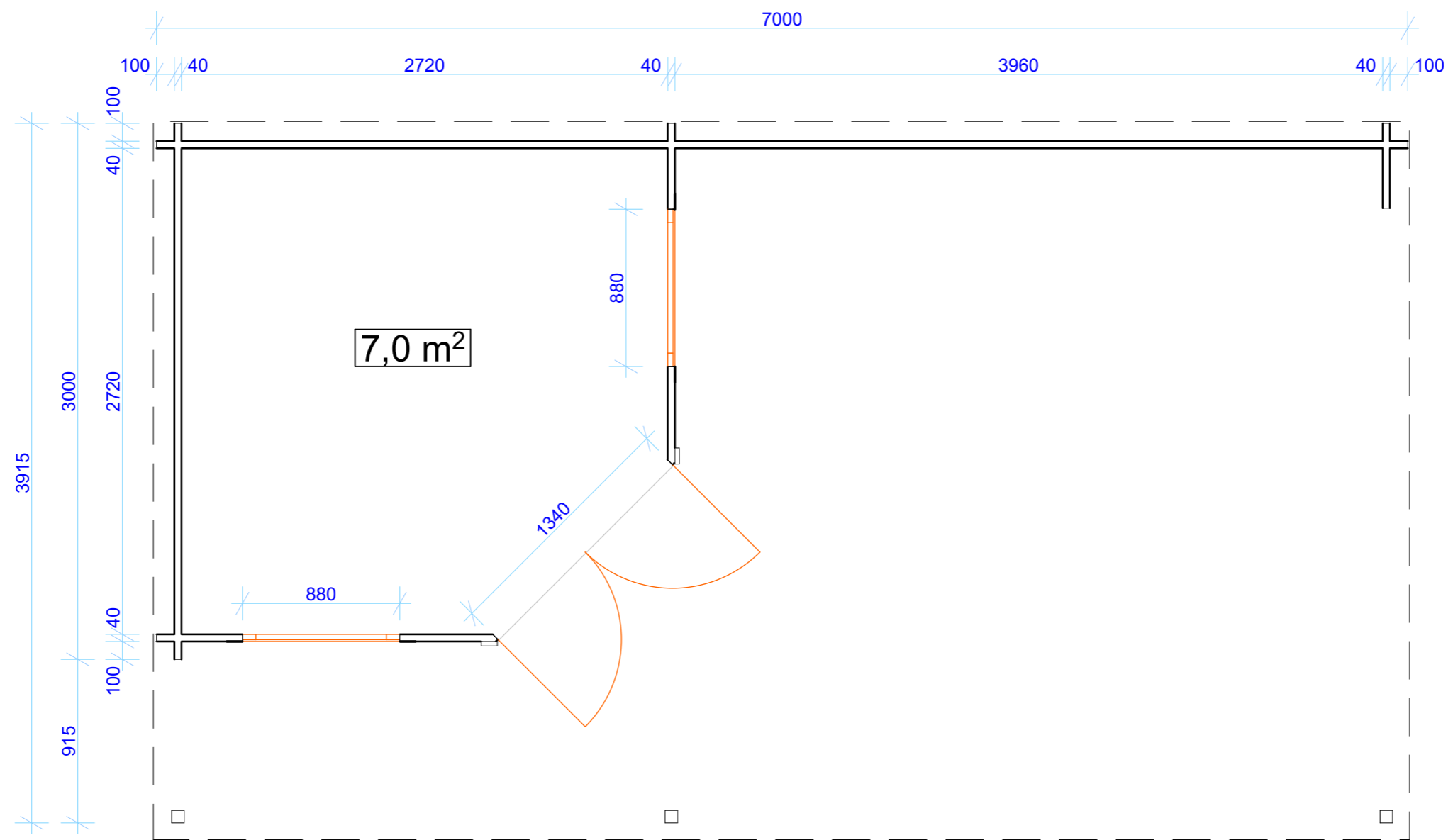





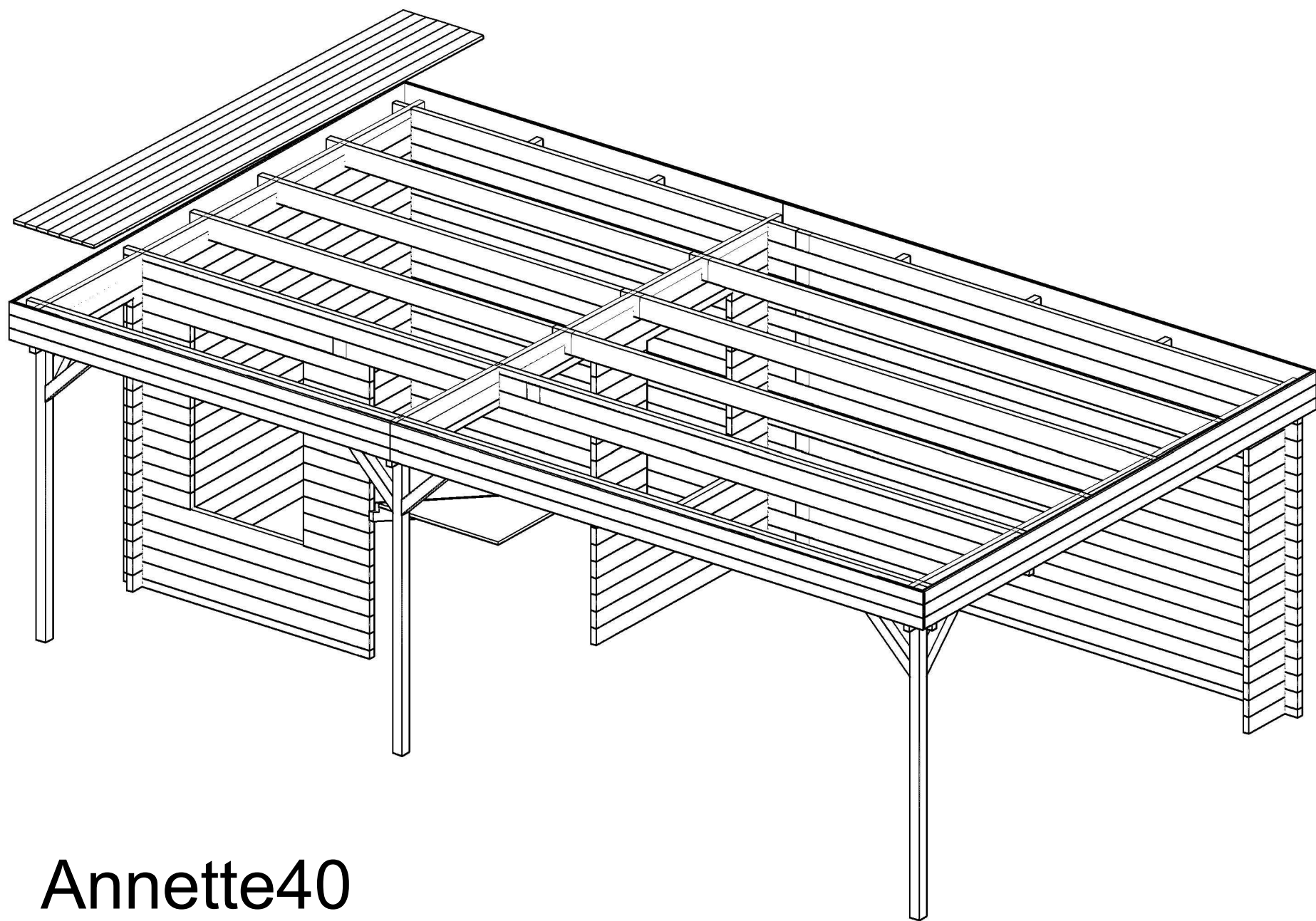



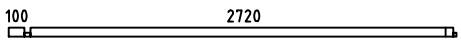
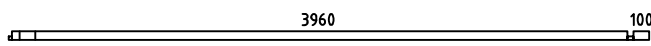
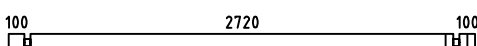
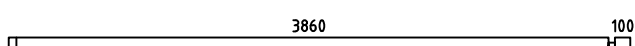
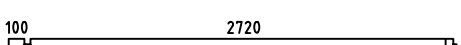
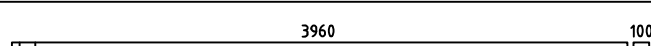
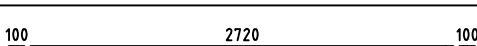
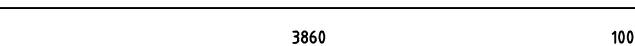
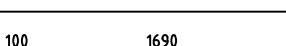
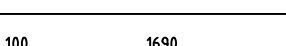

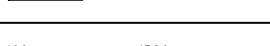
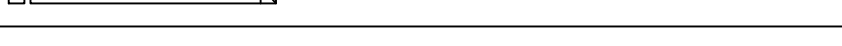
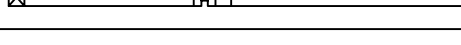
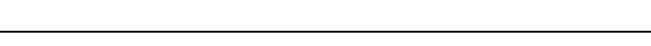
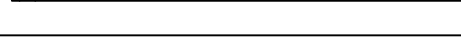
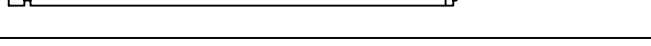
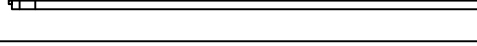
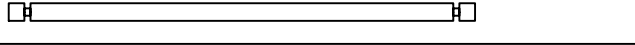
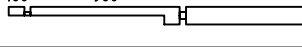
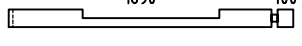

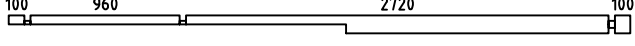
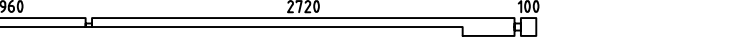

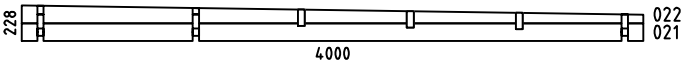
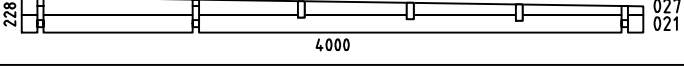

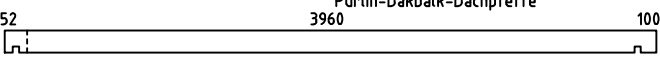
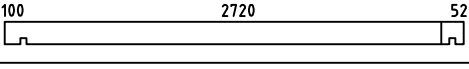
Size (m) 3,00 (+1,0 m porch) x 2,90 (+4,1 m porch)
 Ridge Height 2330 mm
 Wall log 40 mm

	id	size (h x w)	Pcs
Doors	DGD-2	1900 x 1340 mm	1
Windows	DGW-1A	1250x 880 mm	2

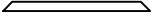

Annette40

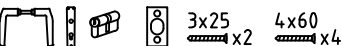
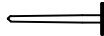
Pos	Specification-Spezifikation-Specificatie	St.	Profile (mm)	Length (mm)
001		1	40x57	2880
002		1	40x57	4120
003		11	40x114	3000
004		11	40x114	4000
005		10	40x114	2880
006		10	40x114	4120
007		1	40x114	3000
008		1	40x114	4000
009		1	40x57	1830
010		11	40x114	1830
011		38	40x114	475
012		21	40x114	475
013		1	40x114	1720
014		1	40x114	5380
015		1	40x41	2880
016		1	40x41	4120
017		1	40x56	2880
018		1	40x56	4120
019		17	40x114	3000
020		1	40x114	4000
023		1	40x114	1830
024		1	40x114	1830
025		1	40x114	4000
026		1	40x114	4000
WA-1		1		
Kood	Materjal	File	Annette40.dwg	Leht 1/3

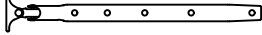
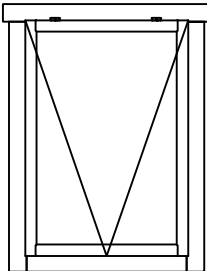
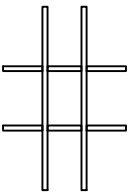
Pos	Specification-Spezifikation-Specificatie	St.	Profile (mm)	Length (mm)
WB-1		1		
WC-1		1		
CS1	CORNICE SUPPORT-TRAGELEISTE FÜR GESIMSE-KROONLIJST STEUNEN BAR 	5	44x70	100
PR2	Purlin-Dakbalk-Dachpfette 	3	44x144	4192
PR1	Purlin-Dakbalk-Dachpfette 	3	44x144	2952
DP-1	Roof board-Dachbrett-Dakplank 	80	88x18	4000
	+POST 85x85 	3		2290
L-1	Cornice-Gesimse-Kroonlijst 	2	20x250	2900
L-2	Cornice-Gesimse-Kroonlijst 	2	20x250	4016
L-3	Cornice-Gesimse-Kroonlijst 	2	20x250	4140
	Diagonal for POST 44x85 	6		500
	Adjustable foot-Stellfuß+Schrauben 4x50 4stück für Post 	3		
PE1	Ceiling Element-Deckenelement-Plafond Element 1 	1	931x1316	
	Double Door Set-Doppeltür Satz-Dubbele Deur Set 	1		
	Nail-Nagel-Spijker 1.2x20 	35	1.2x20	
WD1	Wall Dowel-Wanddübel-Muurplug 	60		
WS1	Window Stay-Fensterfeststelle 	2		
W9N 86.5 X122.5 ISO	WINDOW 865x1225 ISO  Window Glazing Bar Fenstersprossen Raamroeden 	2		
Kood	Materjal	File	Annette40.dwg	Leht 2/3

H = 1.500 m
TOTAL: 24.09 m²

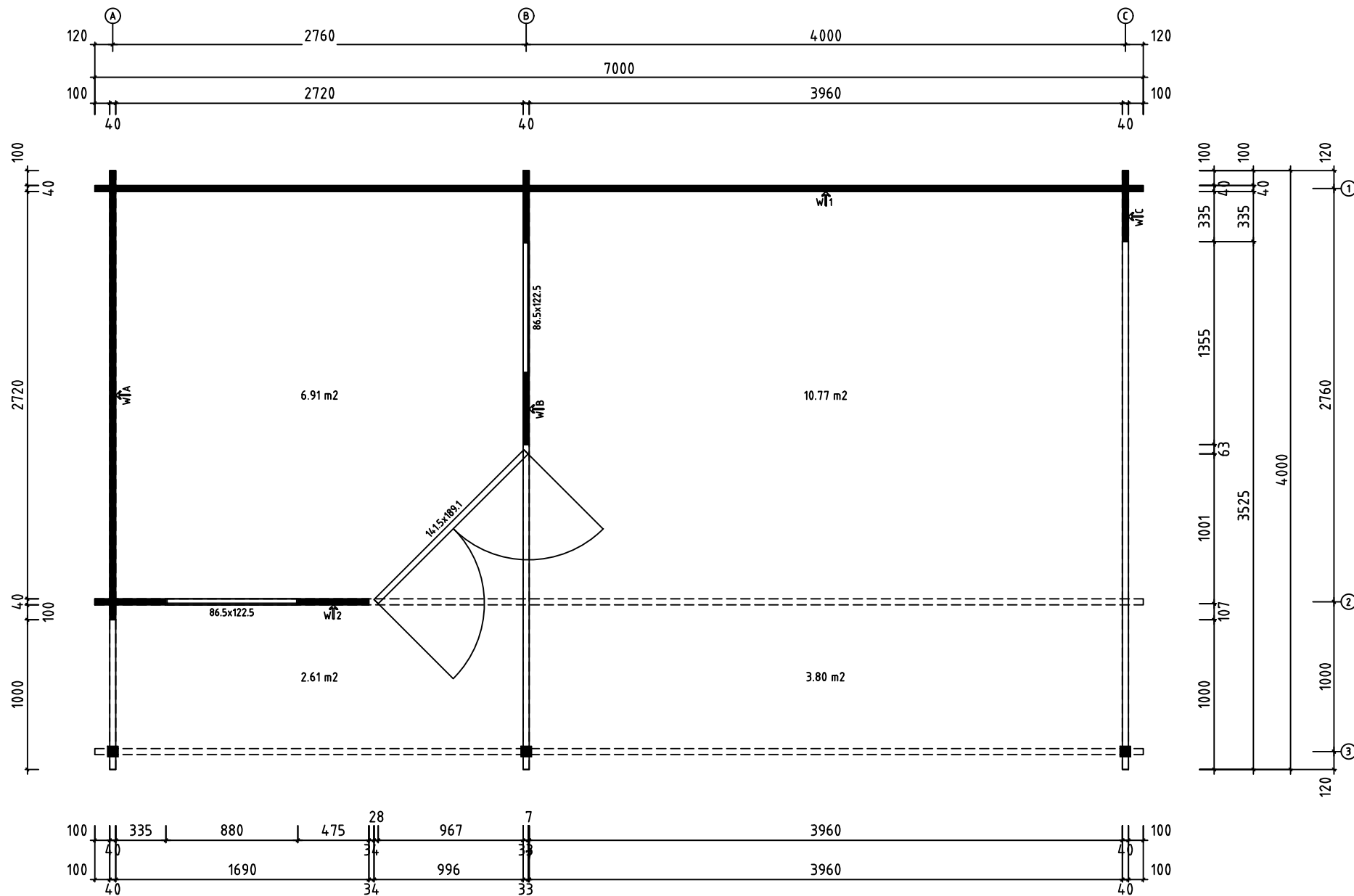

Model	Annette40	Page	PLAN
Client		Scale	1:40
Material	40x114	Date	07.11.2018
Company		File	Annette40.dwg

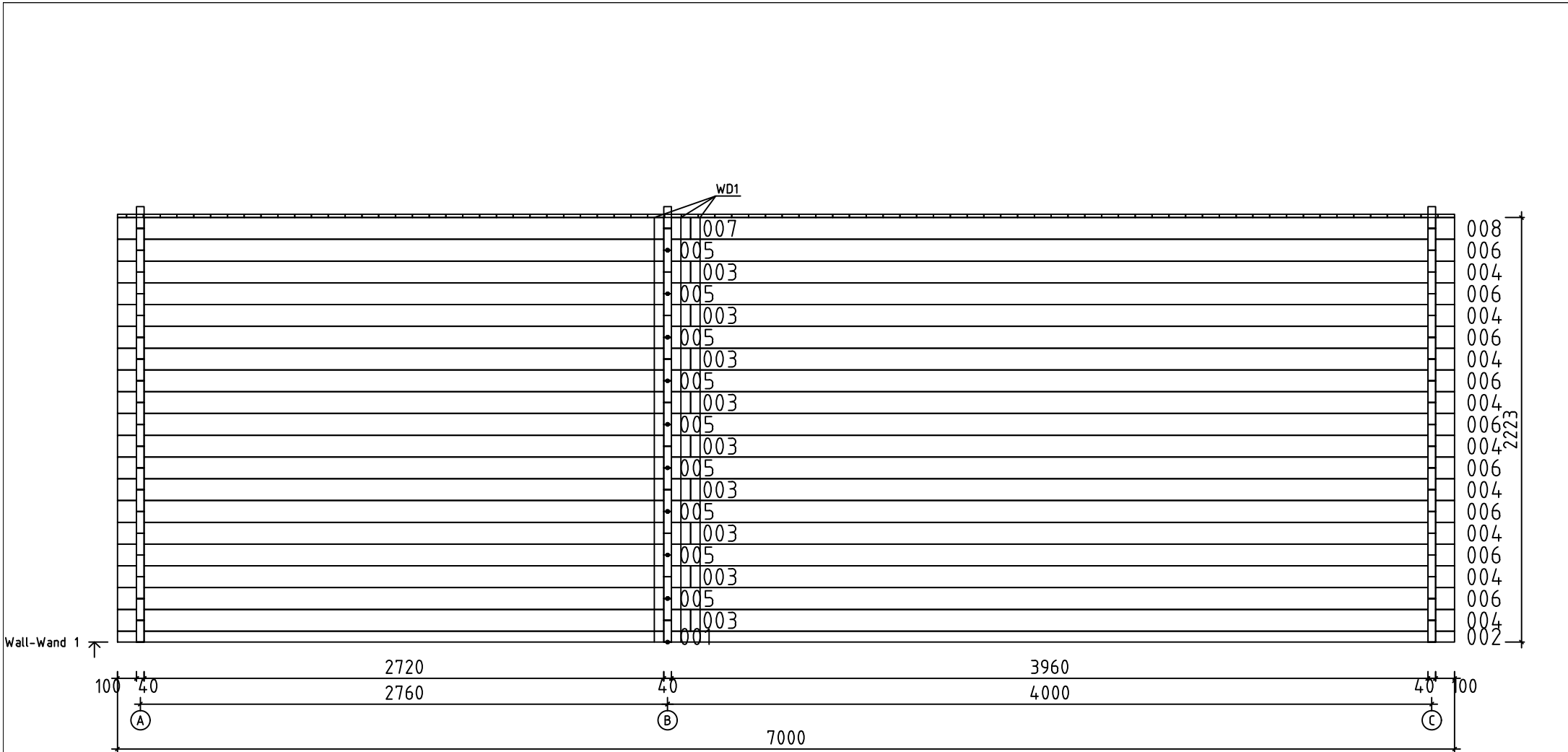

Model	Annette40	Page	6
Client		Scale	1:40
Material	4x11.4	Date	07.11.2018
Company		File	Annette40.dwg

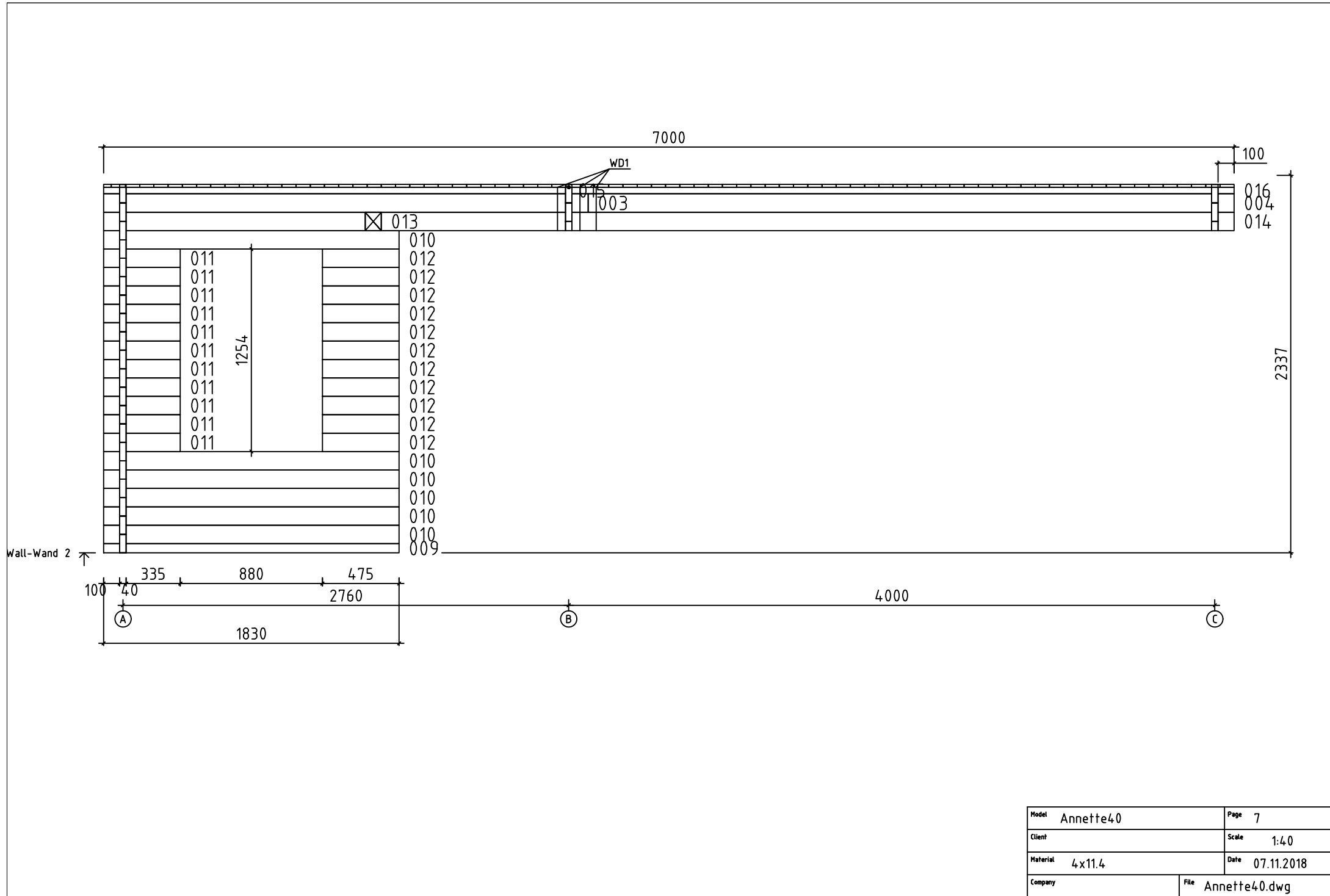

Model	Annette40	Page	7
Client		Scale	1:40
Material	4x11.4	Date	07.11.2018
Company		File	Annette40.dwg

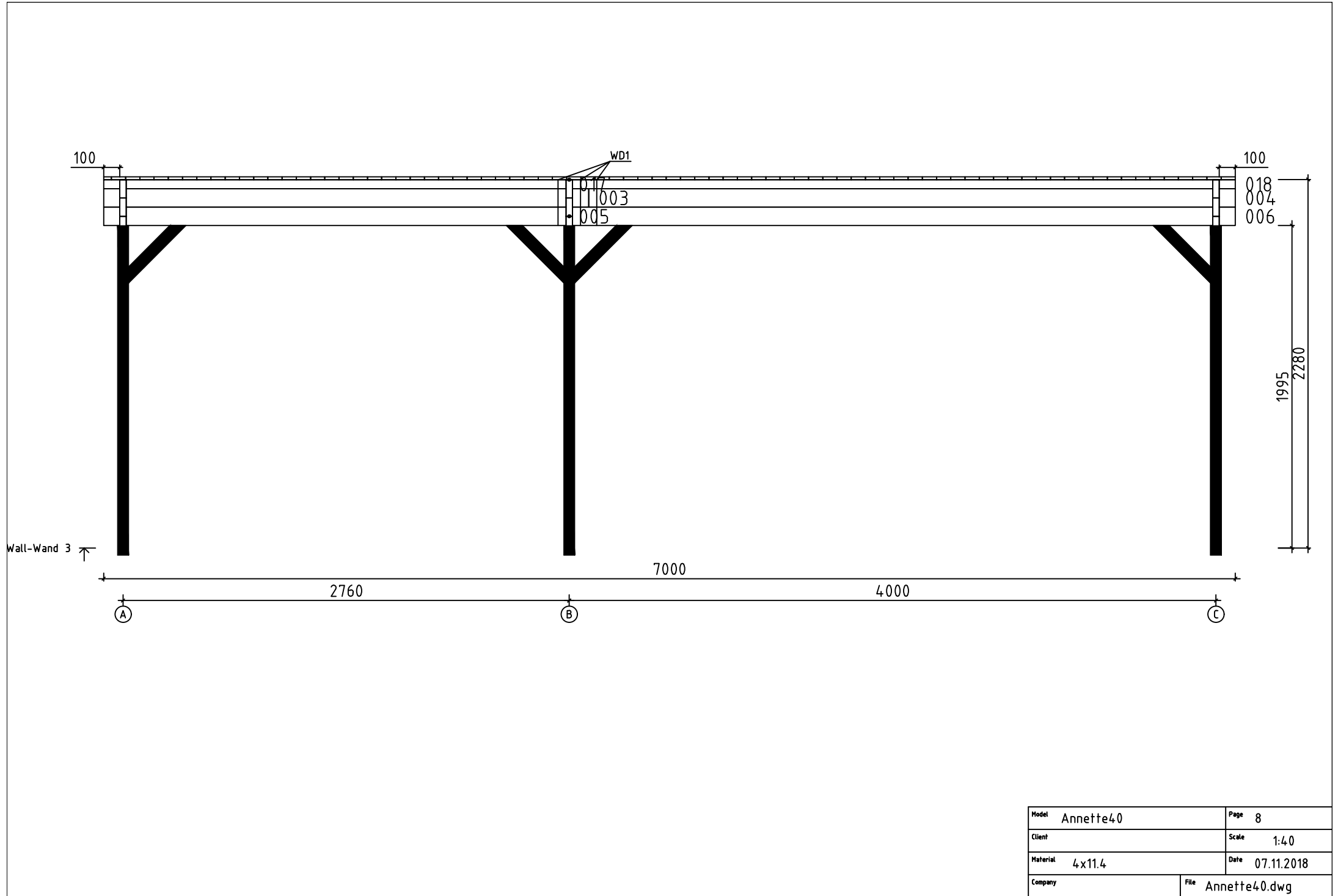

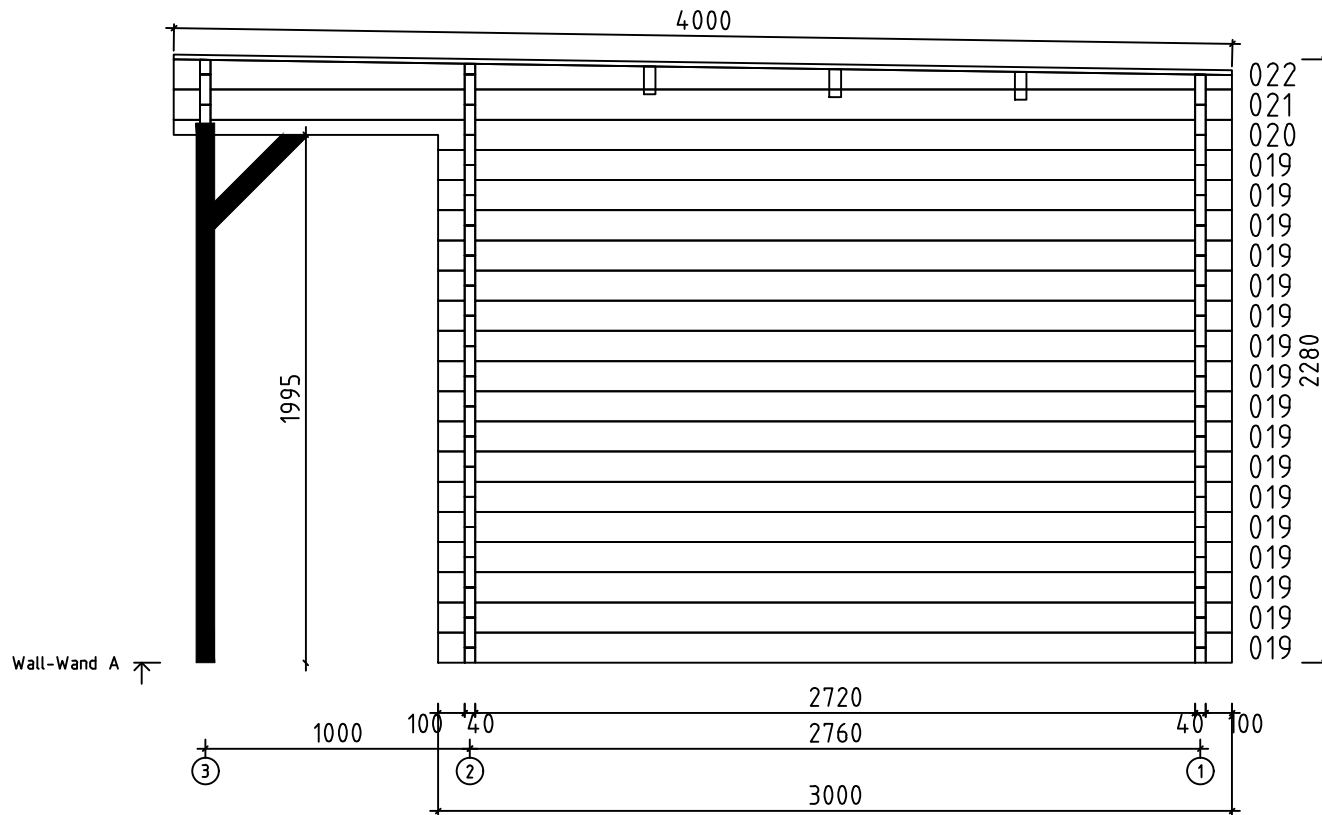

Model	Annette40	Page	2
Client		Scale	1:40
Material	4x11.4	Date	07.11.2018
Company		File	Annette40.dwg

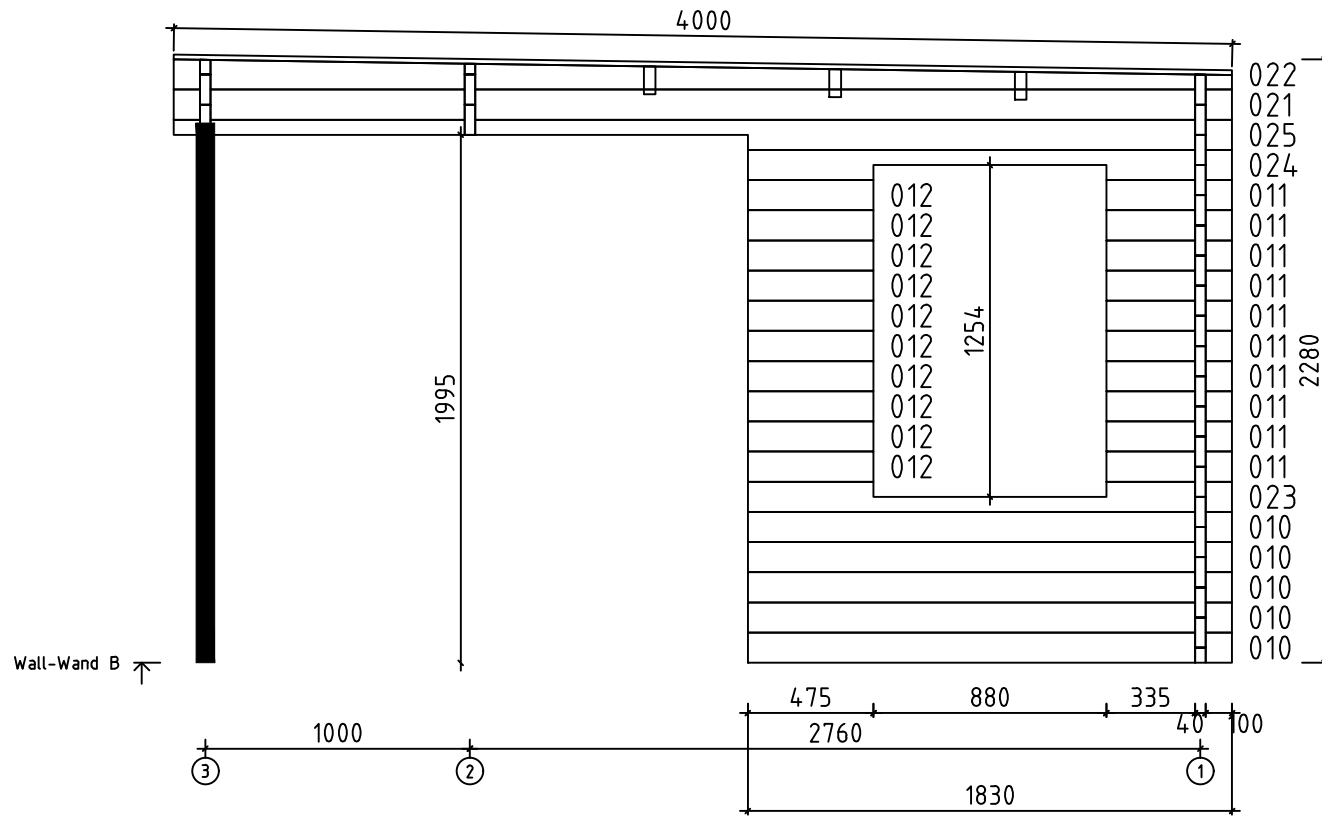

Model	Annette40	Page	3
Client		Scale	1:40
Material	4x11.4	Date	07.11.2018
Company		File	Annette40.dwg

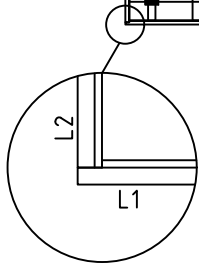
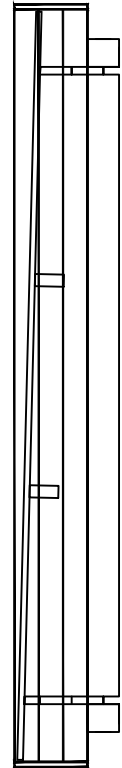
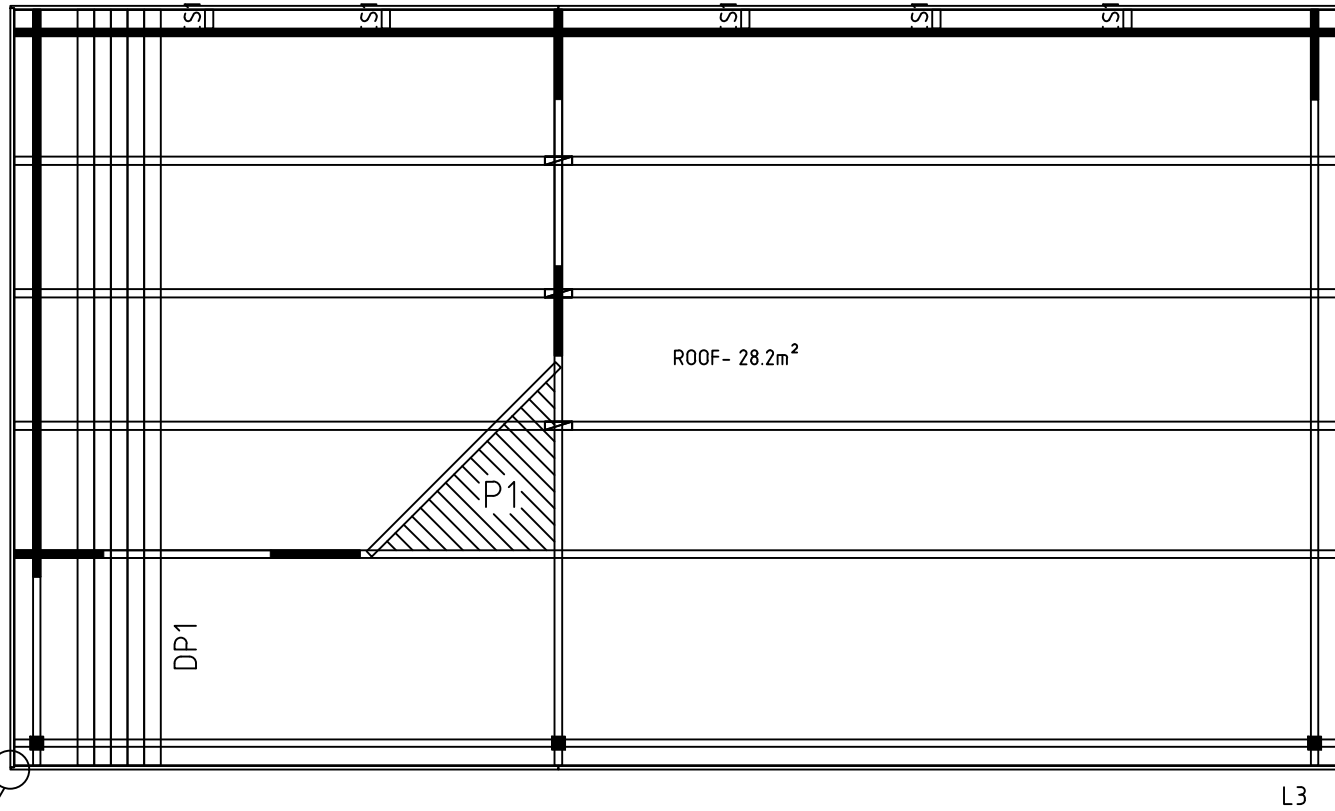

Model	Annette40	Page	ROOF
Client		Scale	1:40
Material	40x114	Date	07.11.2018
Company		File	Annette40.dwg

The guide is illustrative. This guide is not project specification.
Der Leitfaden ist illustrativ. Dieser Leitfaden ist keine Projektspezifikation.
De gids is illustratief. Deze gids is geen projectspecificatie.

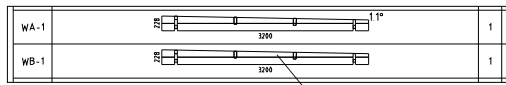

NB!

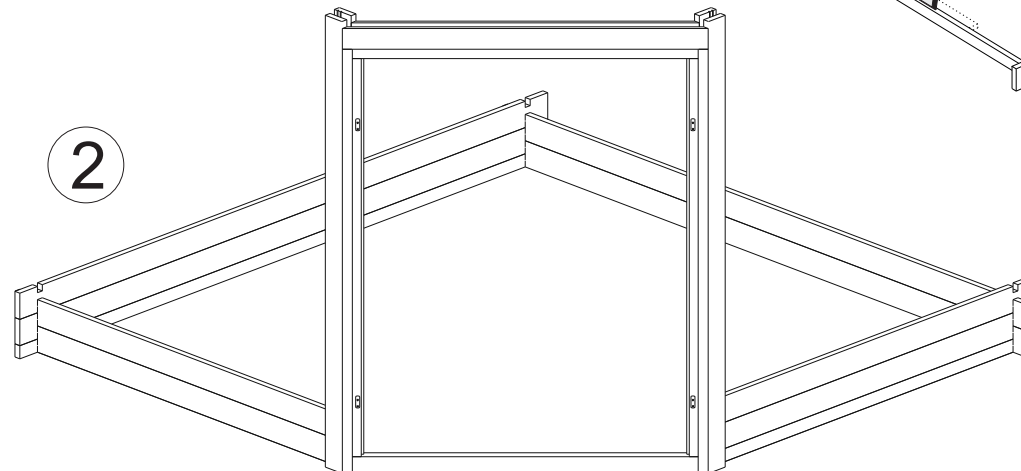
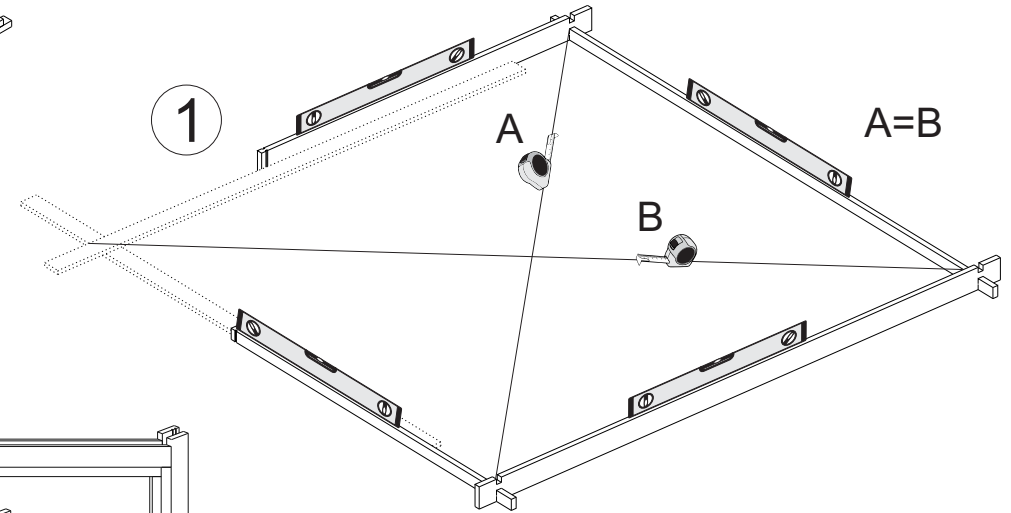
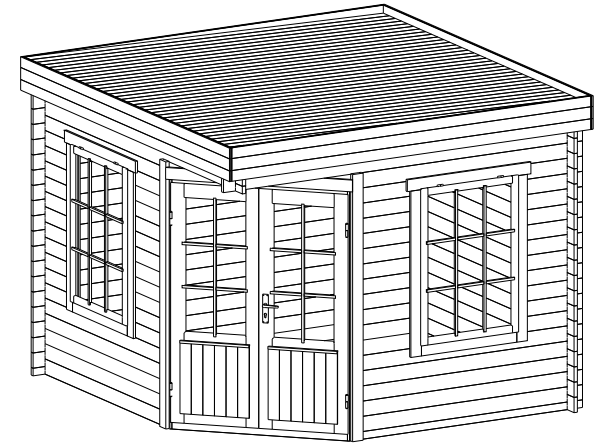
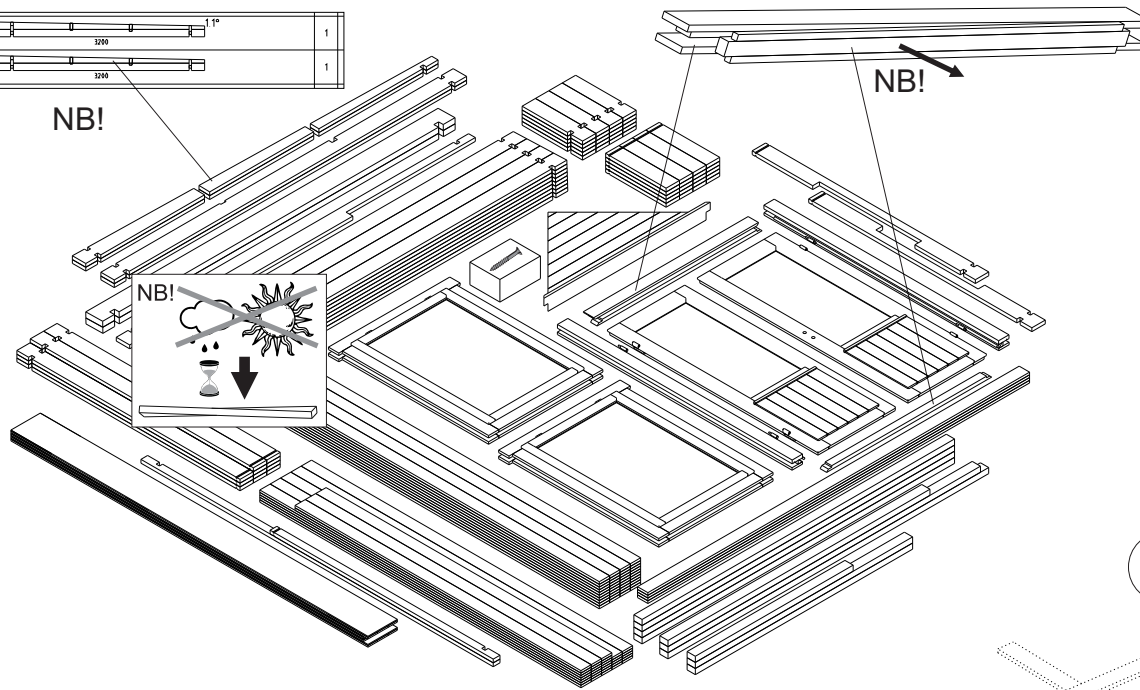

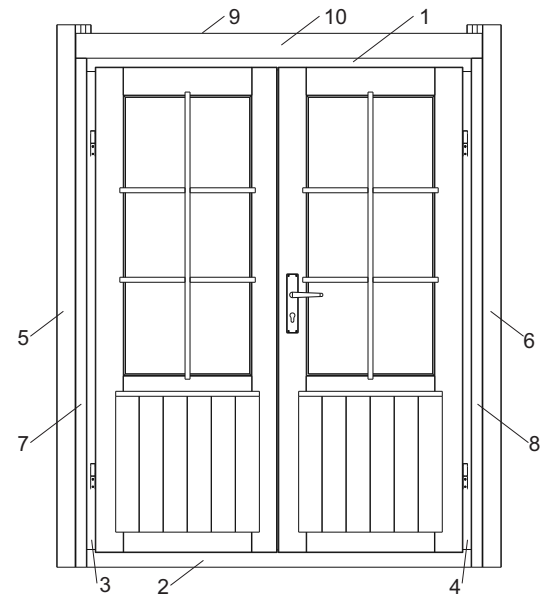
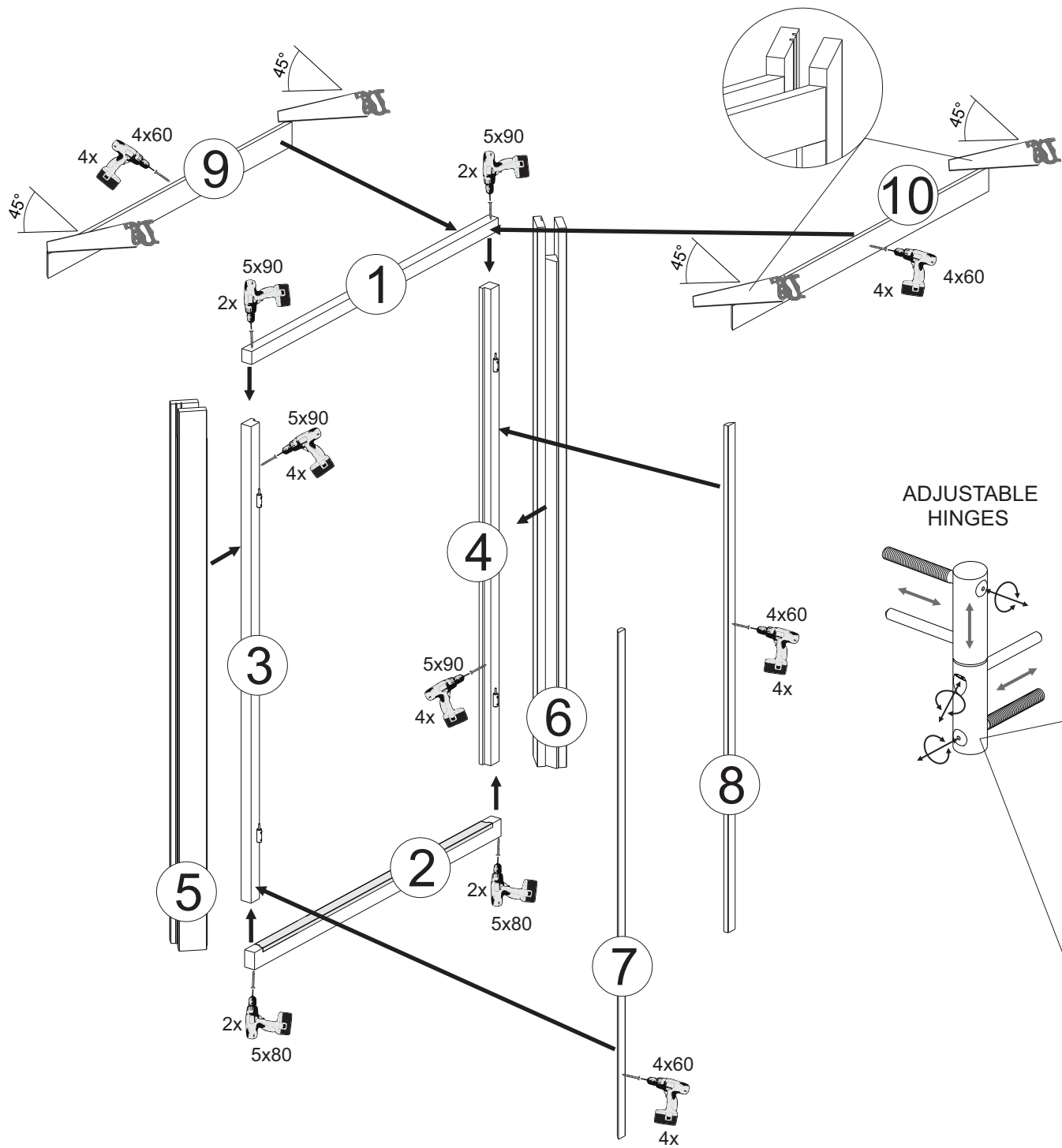

ADJUSTABLE HINGES

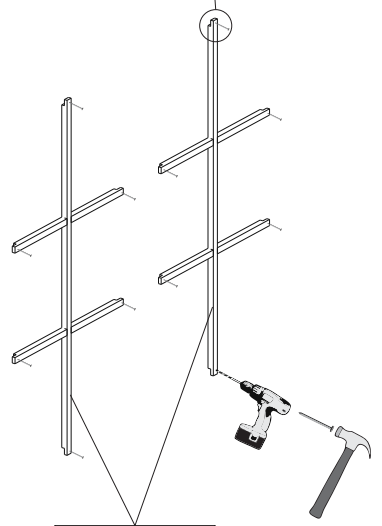
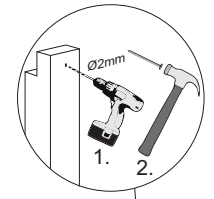
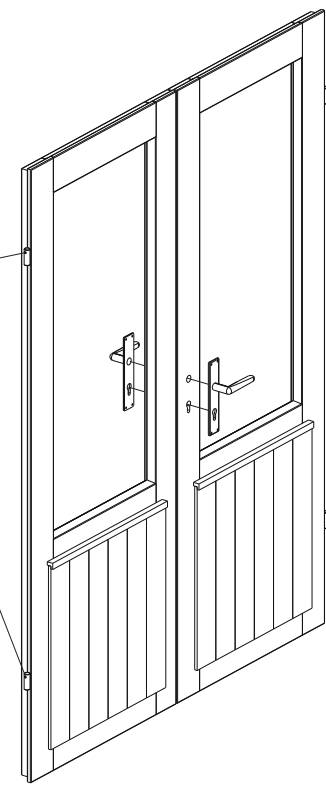
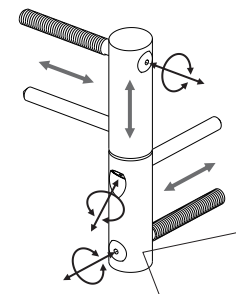

OPTIONS!

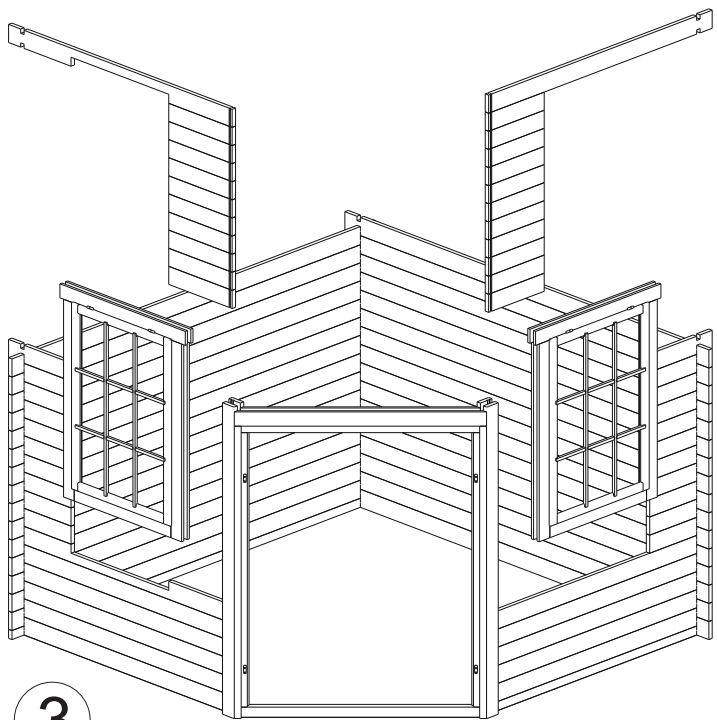

3

OPTIONS!

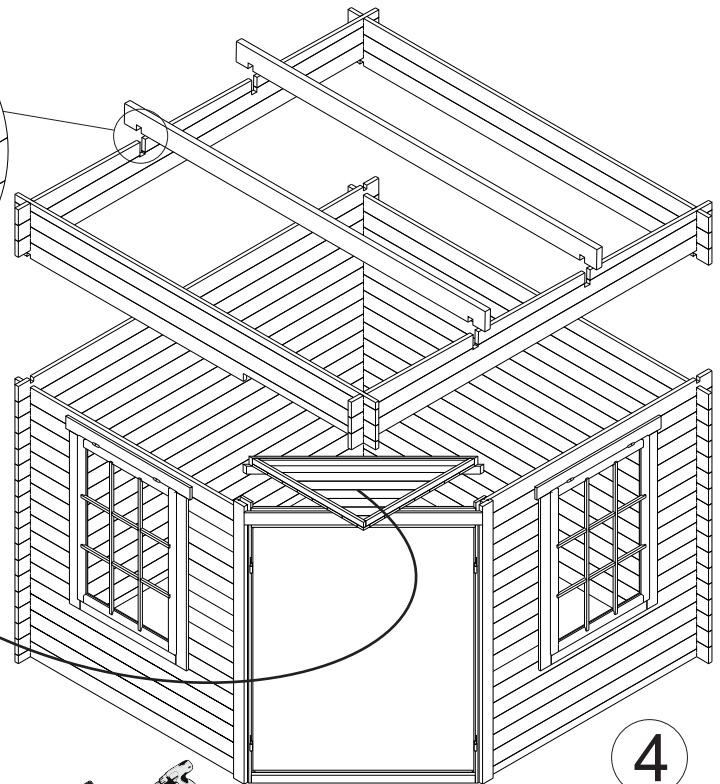
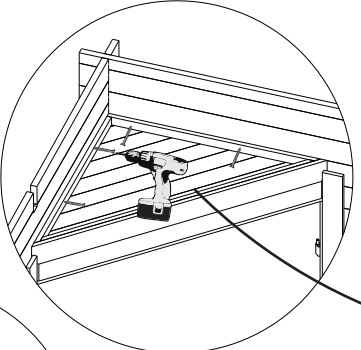
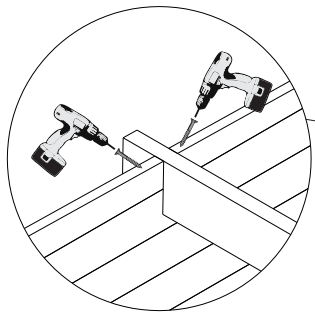
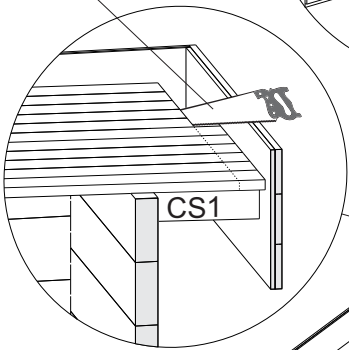

4

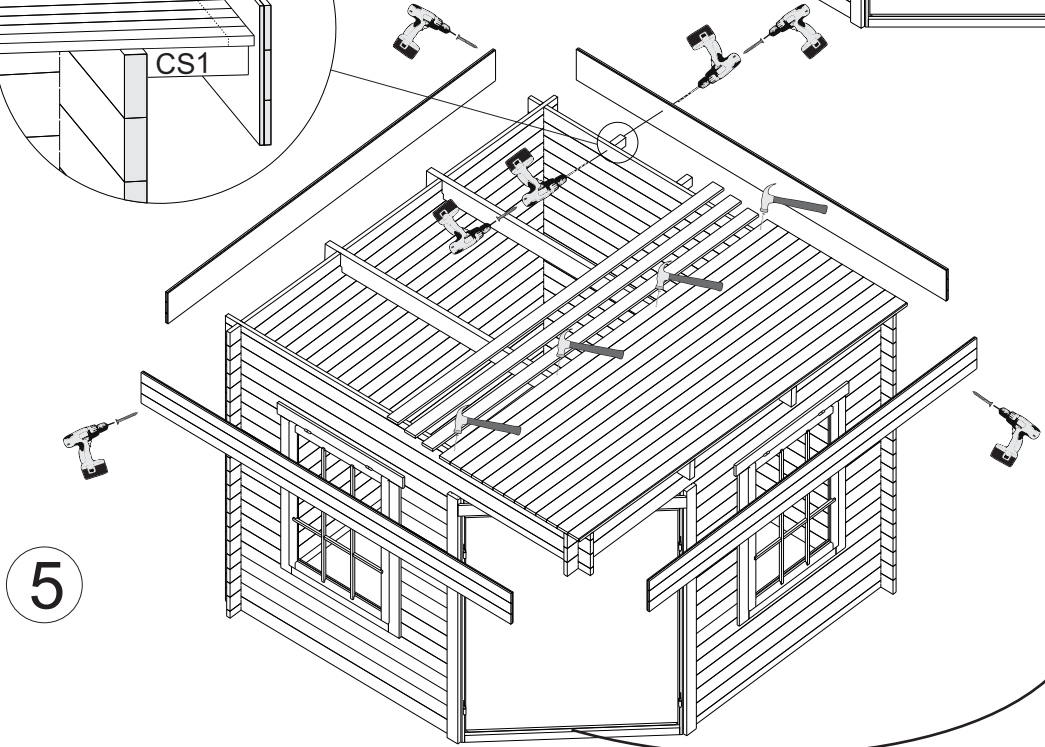

5

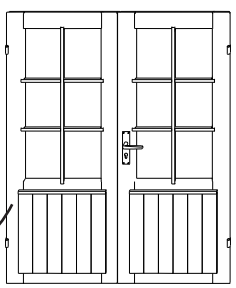

Cutting support post / Schneiden der Stützpfeiler

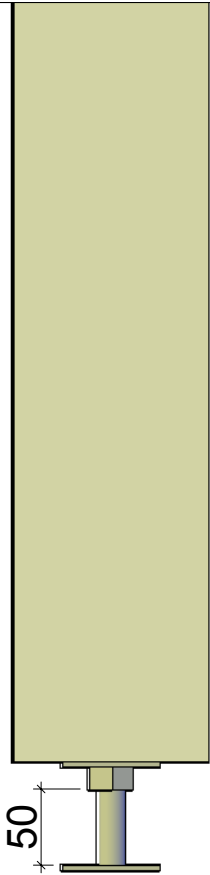

- * Adjustment space for post support should be at least 50mm.
- * Einstellraum für die Pfostenstütze muss mindestens 50mm sein.

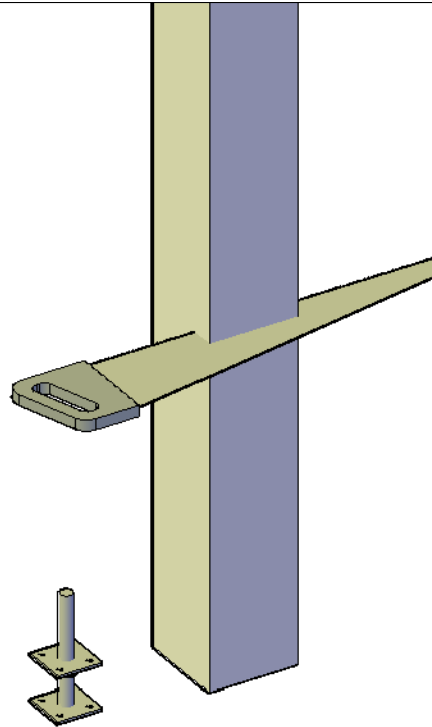

- * Support post has extra length for various conditions. Must be sawn to suitable length on spot considering local conditions.
- * Stützpfeiler hat extra Länge für verschiedene Bedingungen. Muss vor Ort unter Berücksichtigung der örtlichen Gegebenheiten zu einer geeigneten Länge gesägt werden.

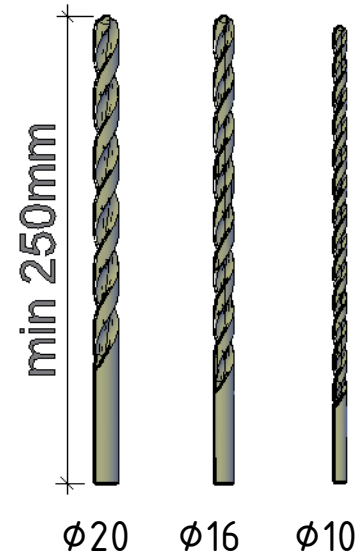
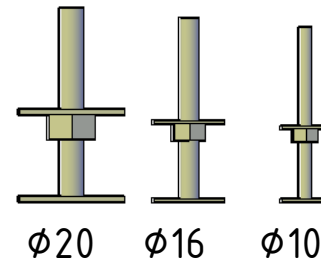

- * In some cases you need to drill a new hole for a post support. Find a matching drill bit.
- * In einigen Fällen müssen Sie ein neues Loch für die Pfostenstütze bohren. Finden Sie hier den passenden Bohrer.

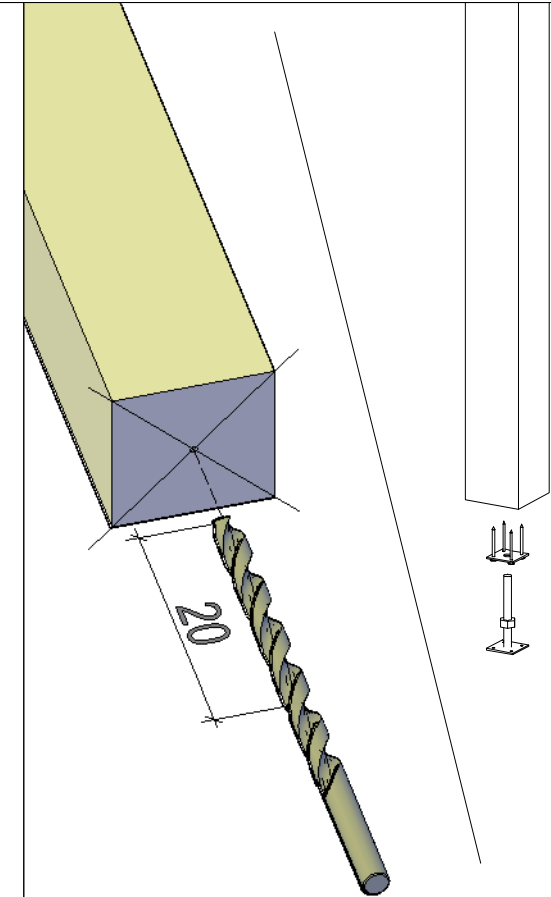

- * Mark the center of the post and drill a new 20cm deep hole. Continue building.
- * Markieren Sie die Mitte des Pfeilers und bohren Sie ein neues 20cm tiefes Loch. Danach mit Aufbau weiter machen.